

User Manual

RANGER

Head-Mounted-Display (HMD)



Subject to technical modifications

WARNING

Before using the RANGER HMD please read carefully these safety instructions.

Read this handbook and use the RANGER HMD in strict accordance in order to prevent any damage to your eye, other injury, loss of visual functions, property damage or death.

Children under the age of fifteen may not use this product.

We strongly advise you to get familiar with the RANGER HMD and its capabilities before you use it for the first time. Please try it and adjust it in quiet circumstances, before using it in conditions under strain.

Table of Contents

Table of Contents	3
1 Safety instructions	4
1.1 Use restrictions	4
1.2 Health concerns	4
1.3 General safety hints	5
1.4 Warning for electrical products	6
2 Content of the RANGER Kit	7
3 Description	8
3.1 Overview	8
3.2 Head-Mounted-Display HMD	9
3.3 Power unit	10
3.4 Charge unit	12
4 General Operating Instructions	14
4.1 Preparation	14
4.2 Using RANGER as Night-Vision Device	18
4.3 Exhausted Battery	20
4.4 Using different Modes.....	21
4.5 Using the Electronic Zoom.....	22
4.6 Using RANGER as a Monitor	22
5 Special Instructions	25
5.1 Replacement camera lenses.....	25
5.2 Adjustment camera lenses.....	25
6 Maintenance and Cleaning Instructions	26
7 Troubleshooting	27
8 Returning used electronic devices in EU countries	29
9 Technical Data	30
9.1 Head-Mounted-Device	30
9.2 Power unit	31

1 Safety instructions

1.1 Use restrictions

- ➔ RANGER is not meant as an aid for driving any means of transportation.
- ➔ RANGER must never be used for driving any type of vehicle, including cars, bicycles and boats. Use of RANGER under these conditions may result in an accident, injury, or death to you or others.
- ➔ Children under the age of fifteen should not use RANGER. RANGER is designed for adult use; it is not a toy.

1.2 Health concerns

- ➔ **WARNING:** Eye Disease, Eye Injury, and Glaucoma

If you have been diagnosed with or are susceptible to eye disease, eye injury, or glaucoma consult your doctor before use and do not use without your doctor's approval.

- ➔ **CAUTION:** Heart Disease, High Blood Pressure

If you have a history of heart disease or high blood pressure consult your doctor before use and do not use without his approval.

- ➔ **CAUTION:** Seizures

If you have a history of temporary spasm, unconsciousness, or epileptic seizures from light stimulation, consult your doctor before use and do not use without his approval.

If any of the following symptoms occur, if using RANGER, stop using immediately and rest:

- eye fatigue or irritation,
- headaches or dizziness,
- aches and pain in the neck or shoulders,
- double vision,
- nausea or motion sickness,
- inability to focus on the displays.

Misuse or overuse of this product may result in eye damage, or loss of visual functions.

1.3 General safety hints

- ➔ Avoid getting the cable entangled around your neck, body or arms. Use the belt pouch for the power unit and wear the cable close to your body.
- ➔ To ensure that the device does not fall off during use, always use the elastic strap, and have it tightened with an adequate tension.
- ➔ Please note that when the power unit is connected to an external TV-, DVD-, Video- or PC-source, the internally built-in camera is non-active. It means the displays of the HMD do not project an image of your environment. For this reason, while using external sources, it is better to stand still or to be sitting when having the RANGER on, as your convenience of movement has been greatly altered.
- ➔ Take care that the battery of the power supply is completely recharged before use. With a full charged battery you can see about 2 hours in the dark.
- ➔ Make sure that you will be in a place with good light and visibility before the battery power is exhausted, or provide yourself with replacement batteries.

1.4 Warning for electrical products

- ➔ To avoid any risk of electrocution, do not bring any part of the RANGER in contact with water when the power unit is connected to an AC outlet (e.g. when recharging batteries, using an external TV-, DVD-, Video- or PC-source).
- ➔ Avoid using and storing the RANGER at wet, humid, dusty and smoky surroundings and extreme temperatures.
- ➔ Do not use RANGER at temperatures below -10°C and above $+40^{\circ}\text{C}$. Avoid dropping or mechanical shock, as frame and displays may be deformed.
- ➔ Always switch off and unplug the RANGER when it will not be used.
- ➔ In case of damage contact your retailer. There are no user serviceable parts. Only qualified service personnel should perform any service required on this product.

2 Content of the RANGER Kit

The RANGER kit contains the following elements. Please check that all of these are included. If any item is not supplied contact your RANGER dealer.

HMD with connecting cable and lens (1),
Power unit (2), Battery (3),
AC/DC transformer with power cord (4), Charge unit (5),
Case (6), Belt pouch (7), Cleaning cloth (8),
Video-Adapter-Cable (9)



3 Description

3.1 Overview

The RANGER is an opto-electronic night-vision device of the newest generation. RANGER enables you to see in poor visibility and in the dark. It allows you to move around safely.

RANGER has a built-in electronic zoom. This provides a magnification of the image of the observed object, bringing it virtually closer. The effect is similar as with binoculars.

RANGER can also be connected to external devices, such as video/television sets, DVD players and computers, or our mobile camera-devices, so that you can view the images inside the HMD.

RANGER consists of the **HMD** and a **power unit with power supply**; a cable connects both parts. The set also includes a main adapter with charger.

RANGER comes in a handy transport case and with a belt pouch.

3.2 Head-Mounted-Display HMD

The HMD contains a high-sensitivity **black and white camera** (1), which records the images around you and transmits them to two **microdisplays** (2) inside the HMD.

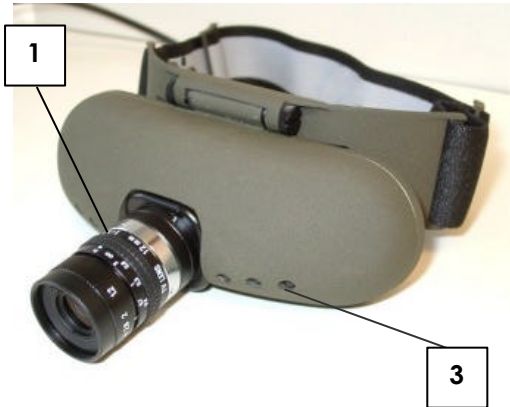

Six infrared LED's (3) beside the camera can also be switched on if the light is poor. This additional lighting is virtually unnoticeable to the eye and is not damaging.

The **cable** (4) is permanently attached to the HMD and is screwed onto the pocket element by means of a detachable plug contact.

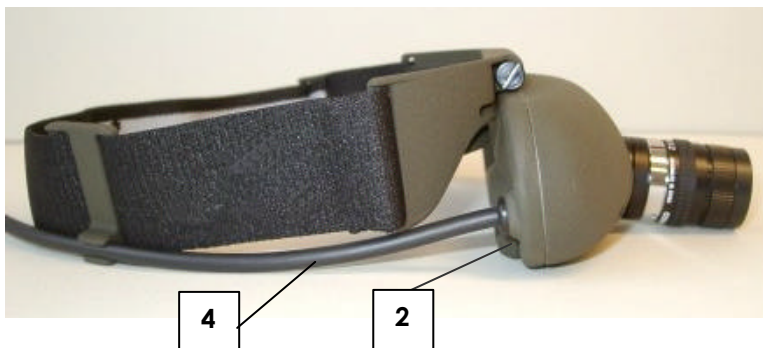

3.3 Power unit

The plastic casing contains the following elements:

- (1) Plug connection for cable
- (2) Push button for power (illuminated)
- (3) Removable Ni-MH rechargeable battery
- (4) Connector for power supply (under the battery)
- (5) Knob with triple function: for manual adjustment of contrast, for electronic zoom or phase, depending upon the mode (see further).
- (6) Knob for manual adjustment of brightness

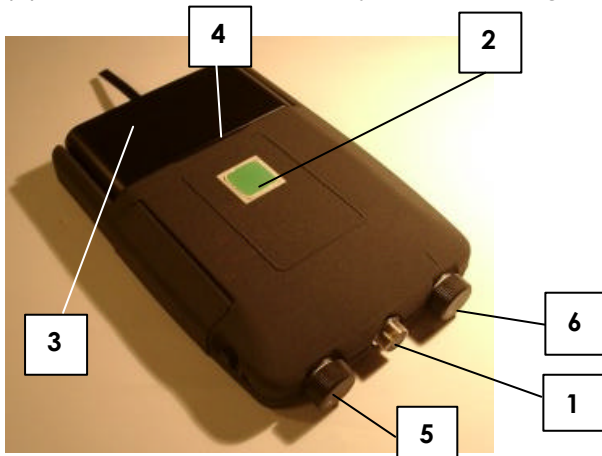

The cable that is attached to the HMD has a plug that must be plugged into the **connector** (1). Pay attention to the mark !
The **push button** (2) on the top of the power unit is used to switch the RANGER on and off. When the device is switched on, a light underneath the button lights up.
The removable Ni-MH **rechargeable battery** (3) enables you to use the RANGER for up to 4 hours (depending on used mode). If you use the additional infrared light, that operating time is reduced to 2 hours. When removing the battery, an **input connector** (4) for an external power supply becomes visible. (see further)

The **knob on the left** (5, page 10) of the plug connection enables manual adjustment of brightness. The **knob on the right** (6, page 10) of the plug connection has a triple function, it enables manual adjustment of contrast, of the zoom function or phase adjustment in VGA-mode.

The **power unit** also contains:

- (1) Push button for infrared light
- (2) Control lamp for infrared light
- (3) Socket connector for external video signal
- (4) Socket connector for other external image sources (SVGA) or computer.
- (5) Button for selecting the input signal mode
- (6) Control lamps

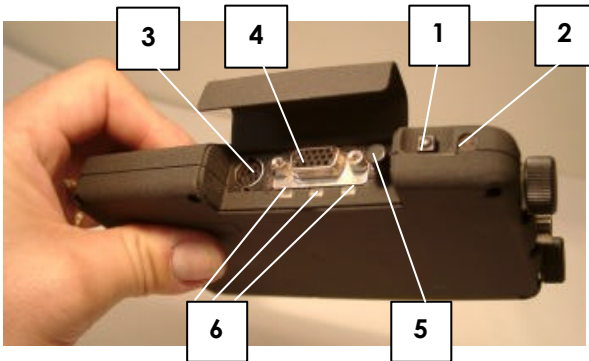

The **push button** (1) for switching on the additional **infrared lighting** and its **control lamp** (2) is situated on the right side of the device.

Underneath the flap on the side of the device, there are **socket connectors for video/S-video** (3) or **SVGA** (4).

An input **selection button** (5) for selecting the mode corresponding to the input signal. Underneath are **three control lamps indicating the active choice** (6).

3.4 Charge unit

RANGER includes a removable Ni-MH rechargeable battery (2) and a power supply unit (1) for generating different voltages, which also includes a charging circuit for a mains adapter (3). It takes approx. 50 min to charge the battery from empty to full if you use the mains adapter supplied with the system. During charging process it is possible to use RANGER parallel.

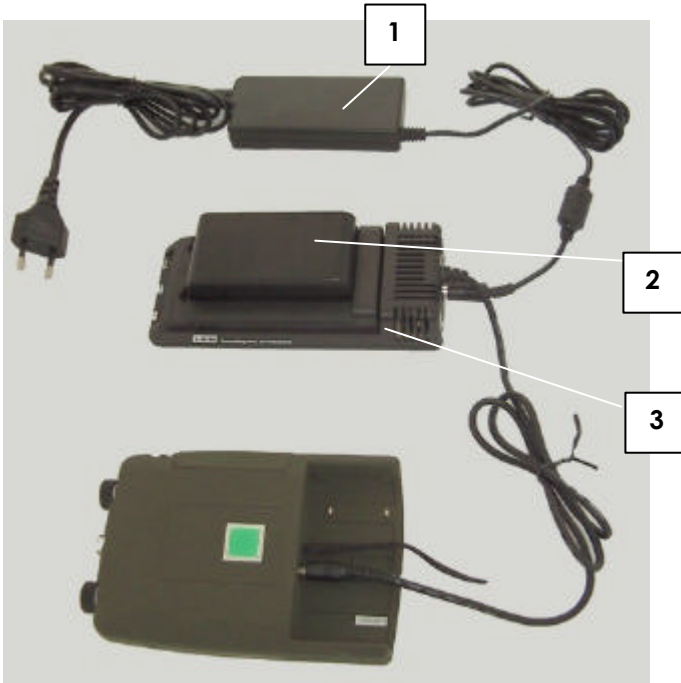

The charge unit has control lights.

- ➔ When loading the unit with a battery to be charged, the **red light** will turn **on**, but only for a while. It should turn off after a certain time (not more than a minute), otherwise it indicates a defect.
- ➔ If voltage input is incorrect or unstable, the **red light** lights up.
- ➔ When charging starts the **green light** will be **on**.
- ➔ When charging is completed, the **green light** will begin to **flash**.
- ➔ The **yellow light** is in relation with the temperature control. If it turns on, the maximum temperature allowed has been reached, and loading is temporarily interrupted.

You may leave the battery in the charge unit without any danger, until charging is complete (= green light flashing).

4 General Operating Instructions

4.1 Preparation

Unpacking the Device

- ➔ Please unpack the devices and compare with the list under paragraph 2 on page 7 to check that all parts are complete. Please contact your dealer if any parts are missing.

Checking, charging and changing the Battery

Before you use the HMD for the first time, please check whether the battery is fully charged:

- ➔ Remove the battery from the power unit. To do so, pull the tape down carefully with one hand and push the battery out of the casing with the thumb of your other hand. For that process do not lay down the power unit on the table.

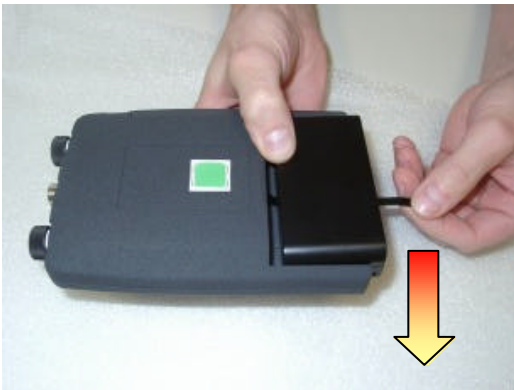

- ➔ Place the battery in the charger so that the brass-coloured contacts of the battery and charger match. Press the battery lightly until you feel it locks into place. The green control lamp on the front of the charger lights up. When the green control lamp begins to flash, the charging process is completed (see paragraph 3.4 on page 12).
- ➔ Replace the battery in the power unit. To begin with, this may require some practice. Please make sure that the contacts of the battery and the power unit match. Holding the battery flat, push it into the power unit as far as the mark. Press down the battery lightly with your thumb and at the same time continue pushing it completely into the power unit until it locks into place. For that process do not lay down the power unit on the table.

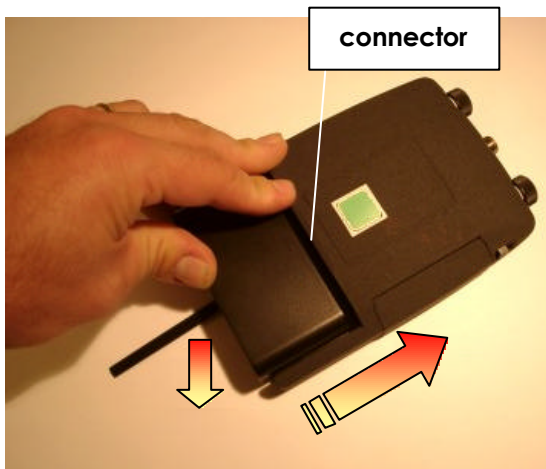

Using the HMD with external power supply

It is possible to have the power supply coming from an external source. One such source is the AC/DC transformer that comes with the charge unit. Its output is 12 V DC, available at the special plug. This plug (see also (4) page 10) fits in in the connector at the battery location of the power unit (visible when the battery is removed).



Connecting HMD and power unit

- ➔ First connect the HMD to the power unit. The cable is permanently attached to the HMD.
- ➔ Insert the plug at the loose end of the cable into the socket at the top of the power unit.
- ➔ The gap in the cable plug must point toward the bottom of the power unit. Insert the plug in the socket and turn the metal ring clockwise to tighten it.

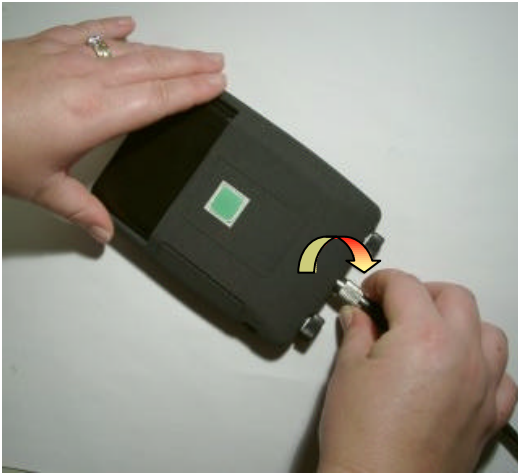

4.2 Using RANGER as Night-Vision Device

Switching on the RANGER

- Switch the RANGER on by pressing the push button on the top of the power unit. When the RANGER is switched on, the button shines.
- After switching on the RANGER, the device is in its basic mode (see paragraph 4.4): in this mode the internal built-in camera is selected.

Attaching the power unit

- Place the power unit in the belt pouch that is supplied with your RANGER. This belt pouch can be attached to your belt. Alternatively, you may prefer to put the power unit in the pocket of your trousers or jacket.

Adjusting the Interpupil Distance

- To optimize the position of the two displays, so that both images are seen as a single visual field, carefully move the oculars into the right position.

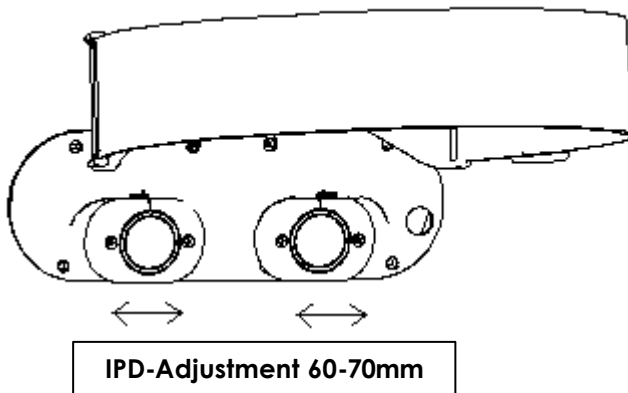

Putting on the HMD

- Put on the RANGER HMD. Place the headband around the back of your head and pull it just tight enough to make it fit safely and comfortably.
- On the displays inside the HMD, you can now see the pictures of your surroundings as recorded by the camera.

Switching on the Infrared Light

- To switch on the infrared light, press the **push button (1)** on the side of the power unit. The red control lamp **(2)** beside the button lights up.

Check your vision. If the infrared light does not enable you to see better than before you switched it on, it is not necessary in these visibility circumstances. Switch it off again to save energy.

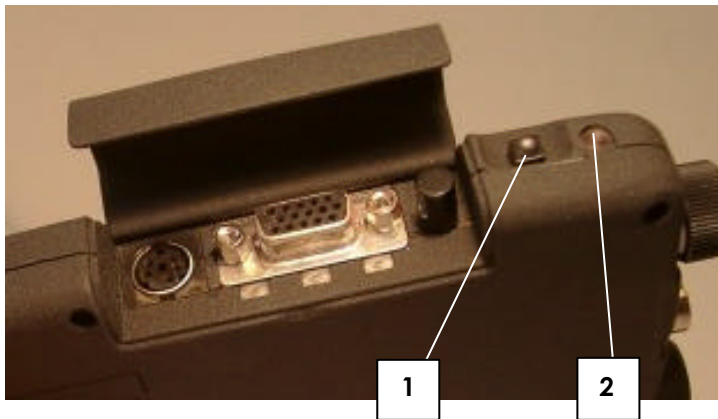

Adjusting Brightness and Contrast

- Adjust **brightness** (1) and **contrast** (2) with the knobs beside the cable connection. Turn the knobs until the image quality you find best. After a little practice, you will be able to find the best position of the knobs quickly.

Please note that you have to repeat this procedure if visibility changes.

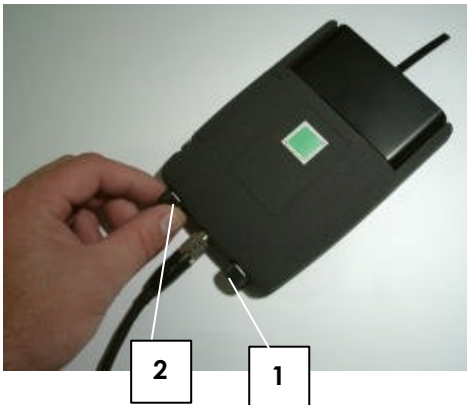

4.3 Exhausted Battery

When the the battery power is exhausted the illuminated power botton will start blinking and a red frame appears around the image. Within a few minutes the system will stop working. Make sure that you will be in a place with good light and visibility to replace the battery.

4.4 Using different Modes

The electronics of your RANGER device allows different functions.

The selection of those functions is governed by the **push-button switch (PBS)** (1) that is located underneath the cover flap on the right hand side of the power unit.

The **basic mode** is the one where the RANGER displays the image as captured by the built-in camera. (see paragraph 4.2)

In this mode the two knobs beside the cable connection control the brightness and the contrast (as explained in paragraph 4.2).

None **green LED** is on (only lit push button (2) on top of power unit, see page 10, indicates this mode).

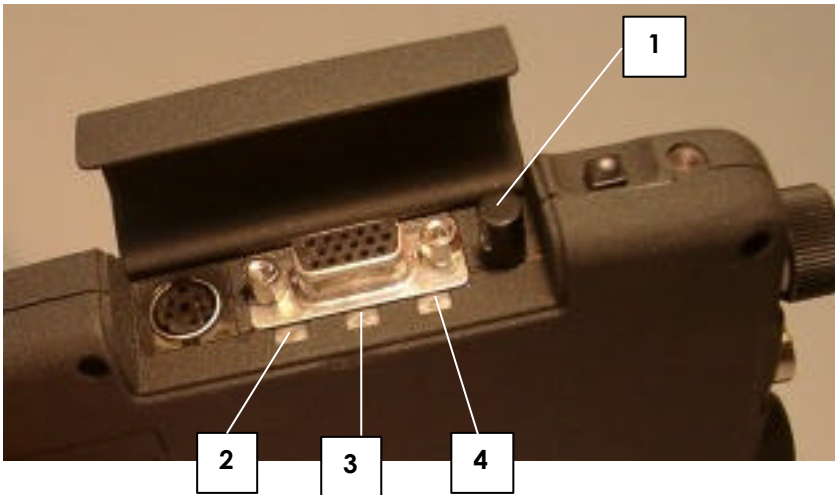

4.5 Using the Electronic Zoom

- This feature allows you to digitally magnify the image in your HMD. It is thus an easy and swift way to bring viewed objects (virtually) closer.
- When pushing the push-button switch **PBS** (page 21, (1)) once, the electronic zoom is activated. It can be noticed by the green frame that appears around both displays in the HMD and the left **green LED** ((2) page 21) of power unit will be on.
- The adjustment of the electronic zoom is set by using the contrast knob on the right hand side of the cable connection. In normal mode this knob controls the contrast. In "electronic zoom mode" the function of this knob has thus changed.

4.6 Using RANGER as a Monitor

You can also use the RANGER to view images from video, TV, DVD or computer. To do so, the external device must be connected to the power unit with its proper adapter cable.

When an external device is connected, you will no longer see the camera image of your surroundings. For this reason, please, move only carefully or not at all.

A static image can burn into the microdisplays after an extended period of time !

- Now the camera signals must be by-passed; it is realised by pushing the **PBS** (page 21, (1)) twice (since switching on the device). That way the built-in camera is disconnected, and the power unit will treat the external image.
The device goes into "video mode". There is an automatic recognition of this signal. The device discerns between "composite video" or "S-video", and it will equally

recognise automatically whether it concerns a NTSC or PAL signal. The **middle green LED** (page 21, (3)) will be lit on to remind you of this mode. When no video signal is connected, this LED will be blinking.

- ➔ If the PBS is pushed a **third time**, the electronic zoom is activated to magnify the external "composite video" or "S-video" signal. It can be noticed by the green frame that appears around the display in the HMD and the **left and middle green LED** ((2)+(3) page 21) of power unit will be on. The adjustment of the electronic zoom is set by using the contrast knob on the right hand side of the cable connection.
- ➔ If the PBS is pushed a **fourth time**, the device goes into "SVGA mode".
You can apply a PC VGA signal 800x600 @ 60Hz, 75Hz, 85Hz or 100Hz.
With the contrast button you can adjust the phase of VGA-signal (see "Power unit" page 10). The **right hand side green LED** (page 21, (4)) will be lit on, to remind you of this mode being selected.
- ➔ Pushing the PBS a **fifth time**, the device goes back into basic mode.

Pushing PBS (1) page 21	3 green LEDs (2-4) page 21	Description
0x	[] [] []	standard mode (after turning on device)
1x	[x] [] []	zoom mode, internal camera, green frame around image
2x	[] [x] []	external video/S-video signal
	[] [b] []	no external video signal detected
3x	[x] [x] []	external video signal zoomed, green frame around image
	[b] [b] []	no external video signal detected
4x	[] [] [x]	external VGA signal
	[] [] [b]	no external VGA signal detected
5x	[] [] []	back to standard mode

[] = LED off

[x] = LED lit

[b] = LED blinking

5 Special Instructions

5.1 Replacement camera lenses

The RANGER is equipped with a special lens mount (CS) that enables easy exchange of compatible lenses. The standard lens supplied with the RANGER offers a one-to-one image of the reality. If you want another view of the surroundings, it is sufficient to mount another lens.

Optionally there are lenses offering an optical magnification of x4 (f=50mm), others give a wide-angle view (magnification x 0.7 lens: f=8mm). For obtaining the correct lens that suits your requirements, please contact your local dealer, or consult any professional photo shop.

5.2 Adjustment camera lenses

The RANGER uses a manual focus (1) and a manual iris (2) adjustment at the camera lens. Therefore it is necessary to find the best image quality manually by turning the two rings of the lens. The relationship between brightness/sensitivity, sharpness and depth of field is the same like in all cameras.

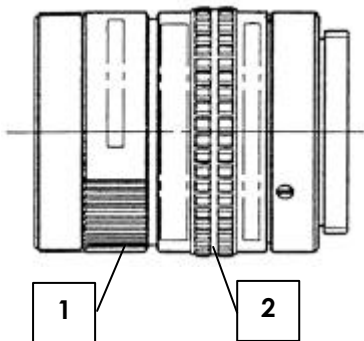

6 Maintenance and Cleaning Instructions

To clean the HMD and control unit, use a damp cloth. A light rinsing agent may be added to the water. Do not use any detergents.

To clean the optical parts of the HMD (oculars, camera lens, infrared LEDs) use a dry, clean cloth. A cleaning cloth for this purpose is provided with the RANGER-kit.

In case of damage contact your retailer. There are no user serviceable parts. Only qualified service personnel should perform any service required on this product.

7 Troubleshooting

Problem	Cause	Remedy
Only dark, or only white image	Incorrect brightness. Brightness knob and/or contrast knob are on max. or min. position.	Adjust by using brightness knob and/or contrast knob
Completely white image	After having used electronic zoom, contrast knob is "deregulated", i.e. at an extreme	readjust contrast
No image	Appliance switched off	switch on RANGER with main push button
Snowy image or no image	Very dark light conditions while IR-LED not turned on	switch on IR-LED
Blinking border in displays; blinking Power-LED	Empty battery	switch off device and first recharge battery or replace
No image	No or bad connection between HMD and power unit	switch off device, plug connection cable into socket and turn metal ring to tighten

Problem	Cause	Remedy
No image	Video cable connected, but wrong video source selected	either connect a video source and select compatible mode for this video signal with PBS or unplug the video cable in order to see with built-in camera
Image dark or image is blurred	Camera lens not clean	clean lens
Only dark, or only white image	Iris of camera lens is closed or opened too much	Adjust the iris according to the ambient light
Unsharp image	Focus of camera lens is not adjusted	Adjust the focus by turning the focus ring of lens
Unsharp image	Range of adjustable sharpness is not enough	Wrong lens mount. Don't use C-mount lenses or use CS-mount adapter ring

All other problems should be performed by a trained and authorised service provider !

8 Returning used electronic devices in EU countries

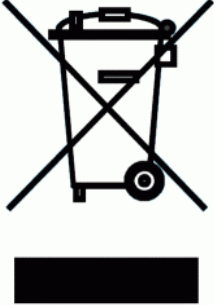
	<p>This HMD and accessories shall not be treated as household waste. The separate collection is a condition for reuse, recycling and utilisation of used electronic devices, which ensures the protection of resources. To comply with german ElektroG (Rücknahme und Entsorgung von Elektro- und Elektronikaltgeräten) and european WEEE (Waste Electrical and Electronic Equipment) electronic used devices from private households can be returned free of charge. For details please contact your local distributor or directly Trivisio Prototyping GmbH (www.trivisio.com).</p>
---	---

9 Technical Data

9.1 Head-Mounted-Device

Camera	black and white
Sensitivity	0,0003 lux @ F 1,4
Camera lens mount	CS
Focus	manually adjustable
Iris.....	manually adjustable
Standard lens.....	12mm (1x vision) F 1,4
	changeable by user
Active IR	6x IR-LED 950nm
Display	2x SVGA microdisplays
	480,000 pixels colour
	equals 1,440,000 pixels
Field of view	approx. 40° diagonal
Eye distance	60-70 mm adjustable
Operating temperature.....	-10°C to +40°C
Weight	176g without lens
Dimensions (W/H/D)	155mm/60mm/60mm

9.2 Power unit

Brightness.....	manually adjustable
Kontrast	manually adjustable
IR-light	manually switchable
Digital magnifier.....	built-in electronic zoom 8x
Mode switch.....	5 modes
Basic mode.....	with built-in camera
Second mode.....	same + digital zoom
Third mode	Composite video, S-video in NTSC or PAL
Fourth mode.....	external video zoomed
Fifth mode	SVGA (from PC) 800 x 600@ 60/75/85/100Hz
Weight	approx. 380 g (incl. battery)
Dimensions (W/H/D).....	105mm/155mm/25mm
Operating temperature.....	-10°C to +40°C
Battery	changeable + rechargeable Ni-MH 6V/2, 1Ah
Charging time.....	approx. 50 min, with enclosed power supply
Operating time.....	approximately based on standard batteries:
	2 h (internal camera)
	1¼ h (internal camera +IR)
	2 h (external video source)
	4 h (external SVGA source)